

ULTIMAT FUTURA

The true professional straight-line mount cutter for the modern framer

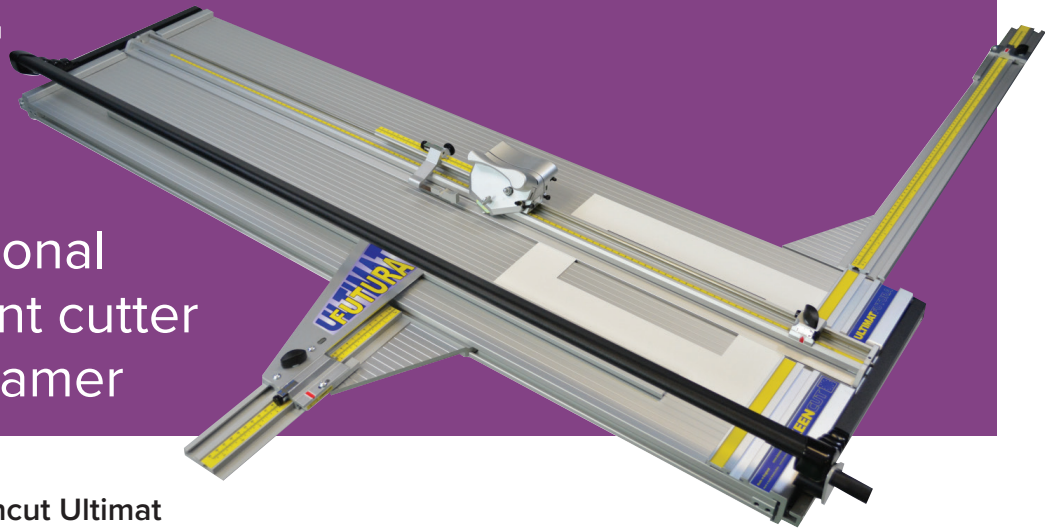

The precision engineered Keencut Ultimat Futura combines advanced design with unique versatility to take manual mount cutting to an unrivaled level of accuracy and speed.

The unique cutting head of the Ultimat Futura, with self-aligning ball bearing rollers, operating on twin steel tracks, delivers a sliding action that is smooth, precise and friction-free under load.

The geometry of the ergonomic head, comfortable for both left and right-handed users, also ensures that operator effort is minimal even when cutting thick 8 ply boards.

The swappable magnetic blade holders make changing blades for different depths of cut a

simple operation, so necessary for the many different types of work processed in a busy framing workshop.

Keencut Futura features include the roller 'lift and hold', the patented Micro-Stops and the non-warp aluminium baseplate.

The superb high performance slideway and cutting head system is designed to meet the demands of framers using all types and thicknesses of mountboard. All this technology further enhances Keencut's status as the world leader in manual mountcutter design.

KEENCUT ULTIMAT FUTURA - Outstanding Features

Specifically designed to cut the most dense of modern mountboard with ease

Beautifully Engineered Cutting Head

With swappable magnetic blade holders - switch to cut different thicknesses of board in seconds

- Ergonomically designed cutting head makes the Futura easy to use over long periods and is suitable for operation by left and right-hand. Makes both bevel and vertical cuts
- Delivers a sliding action that is smooth, precise and with no discernible friction under load
- Maximum operator effort is transmitted to the blade to put the cutting of even 8ply mount board within the capability of every framer.



High Performance Ball Bearings

The cutting head rolls on steel ball bearings gliding on twin steel tracks

- Cutting head of the Ultimat Futura features a set of built-in self-aligning ball bearing rollers operating on twin steel tracks in the aluminium slideway. Designed to give a lifetime of straight, accurate and silent cutting
- The ball and thrust bearings used in the Ultimat Futura are covered by a 20-year Guarantee.

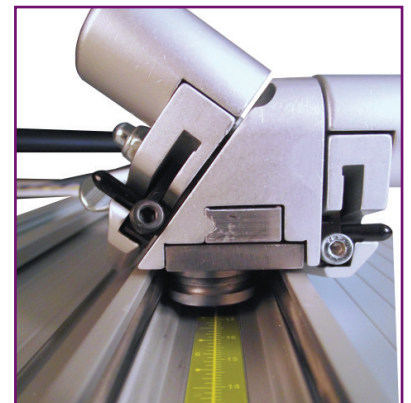

Unique Roller 'Lift and Hold' system

Raises or lowers the cutter bar and frees both hands for mat handling and makes routine setting and working a pleasure

- Operates in one smooth and silent movement. When used instead of the main handle it reduces the already low lifting effort for easy all-day working.

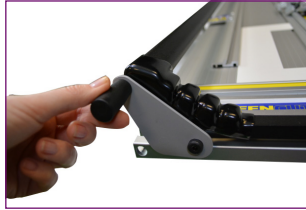

Removable Squaring Arm

The instant clip-on, clip-off, right squaring arm with repetition stop helps you to accurately size all matboards from 900mm (36") down to 40mm (1.5")

- Optional board supports, 2482, clip onto the base to hold large boards flat and square.



Clip-on Margin Guide & Board Squaring Arm

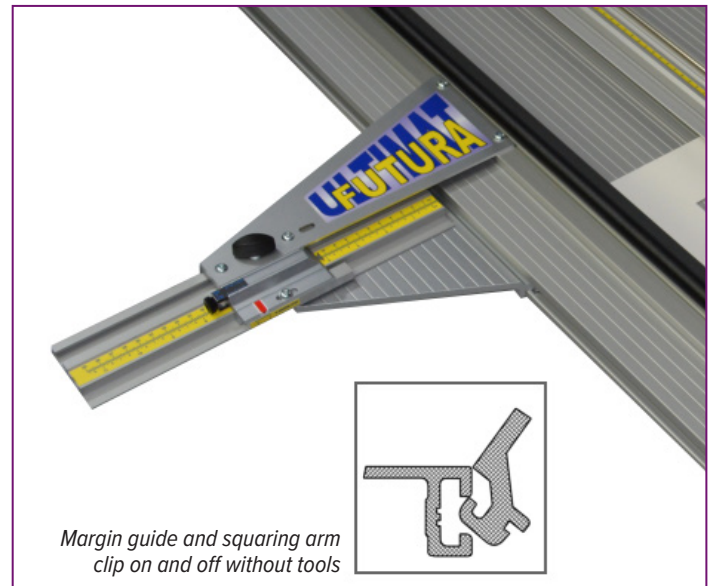

Bevel & Vertical Cutting Head features

Spring loaded bevel cut and vertical cut blade holder feature ball and thrust bearings for perfect alignment and superb blade control

- Vertical blade may be locked in the up position for safety, and locked down for convenience when cutting
- Press progressively against a light spring to effortlessly cut through thicker board or multiple sheets with a number of passes.



Unique Sliding Start-of-Cut Finger

The unique spring loaded measuring stop slides with the cutting head.

- Depress finger to make contact with the mount edge to precisely control start of cut
- When cutting mats large or small, square or rectangular, the stop does not need to be reset
- Set the stop to zero to precisely indicate the start and stop points of the cuts when cutting multiple openings or special effects that have been laid out with pencil lines.

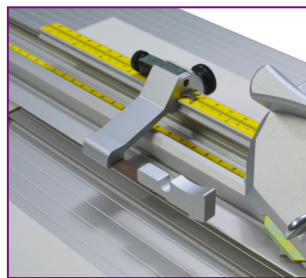

Margin guide, squaring arm and optional board support arms are easily removable for space saving or safety

'Clip On' Margin Guide

- Built in 'micro stop' for measuring margins up to a maximum standard width of 190mm (7.5")
- The rigid T-bar Margin Guide is extendable up to 750mm (30") using the optional Matguide Extension Kit, 2484. This gives accurate all-round location for title boxes and multiple aperture cutting
- When cutting large mountboards down to size using the vertical cutter blade and squaring arm
- For users wishing to free-hand cut margins greater than 190mm.

Unique patented 'Micro-Stop' Adjusters

Fitted to the 'start of cut,' 'end of cut' and 'margin guide' stops to dial out overcuts or undercuts in seconds

- On the Futura, the routine stop adjustments for different thicknesses of board are reduced to just two:
 - Any overcut is eliminated by turning the stop thumbscrew towards minus (-)
 - Any undercut is eliminated by turning the thumbscrew towards plus (+)
- No other mountcutter offers anything as simple or as precise.



Unique and beautifully engineered cutting head and slideway

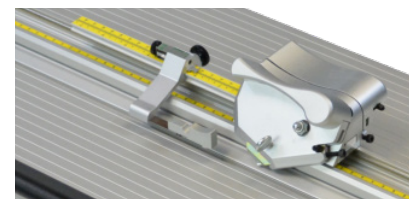

7572	Ultimat Futura	1000	£1280.00
7573	Ultimat Futura	1200	£1350.00
7574	Ultimat Futura	1500	£1420.00

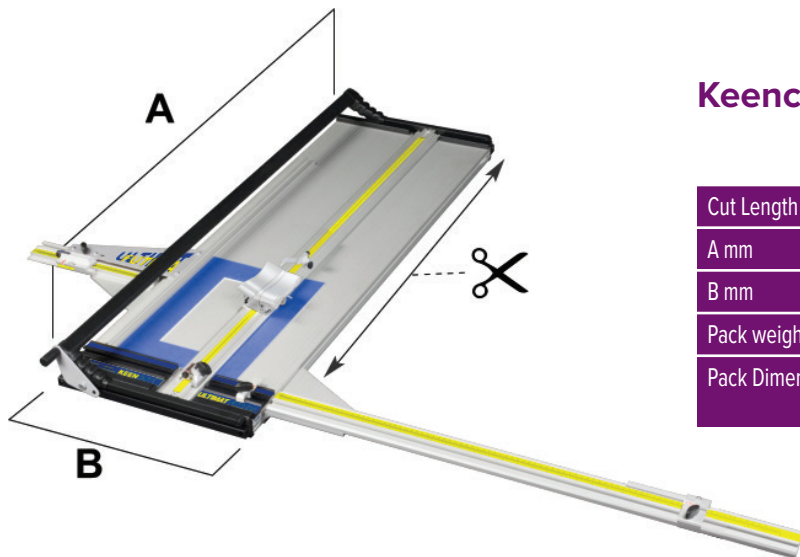

Keencut Ultimat Futura range

	Futura 1000	Futura 1200	Futura 1500
Cut Length mm	1000 (40")	1200 (48")	1500 (62")
A mm	1240 (49")	1440 (57")	1740 (68.5")
B mm	390 (15.5")	390 (15.5")	39 (15.5")
Pack weight kg (lbs)	18 (40")	20 (44")	23 (51")
Pack Dimensions mm	1270 x 440 x 150 (50 x 17 x 6")	1490 x 440 x 150 (59 x 17 x 6")	1840 x 440 x 150 (72 x 17 x 6")
	7572	7573	7574

KEENCUT Mountcutter Blades

Made in Sheffield, UK, specially for Keencut, to their exacting specification. Honed edges, for very smooth cuts.

Tech-D blades are double sided. These are the most commonly used blades for most tasks.

Tech-S are single sided. These blades are sharpened on one side only - some find that these help reduce hooking at corners. Insert them so you can see the bevel.



Bevel cut



2493	Tech-D 0.012" D	100	£20.92
3008	Tech-D 0.015" D	100	£20.92
3845	Tech-S 0.012" S	100	£20.92
6162	Tech-S 0.015" S	100	£20.92

Straight cut

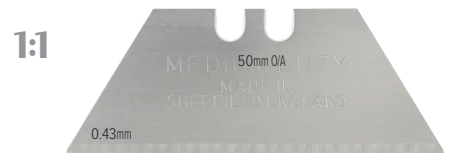

Medium Duty blade fits LASER, ULTIMAT, ULTIMAT GOLD & ULTIMAT FUTURA, etc.

7513	Medium Duty	100	£8.24
------	-------------	-----	-------

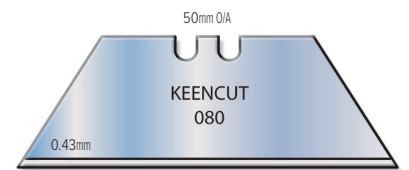

080 Superior quality trapezoidal blades for general purpose and special tasks.

1078	080 Blade	100	£23.80
------	-----------	-----	--------

For our full range of blades see the current Lion Trade Catalogue or visit: www.lionpic.co.uk

Board Support Arms, 600mm long Optional



2482	Board Support Arms 600mm	pk 2	£45.15
------	--------------------------	------	--------

Additional Blade Holders Optional

For those users wishing to set and maybe colour-code with a marker pen a choice of blade holders to quickly and easily switch between different board thicknesses without re-adjusting the blade depth.



Bevel Blade Holder
Keencut product code: KEEFBC



Vertical Blade Holder
Keencut product code: KEEFVC

KEEFBC	Bevel Blade Holder	1	£11.83
KEEFVC	Vertical Blade Holder	1	£11.83

Multi-Angle Cutting Gauge Set
Optional

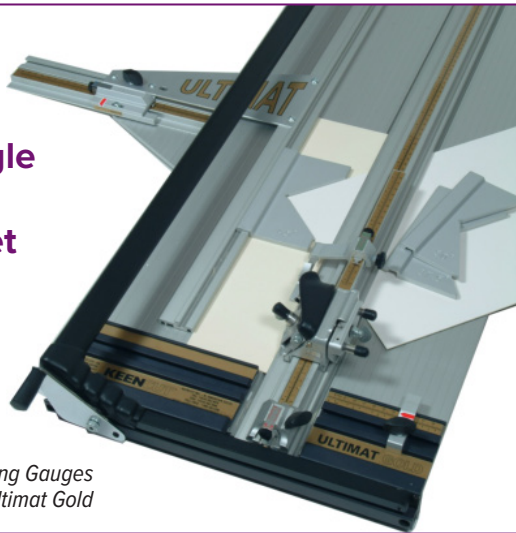

Multi-Angle Cutting Gauges shown on an Ultimat Gold

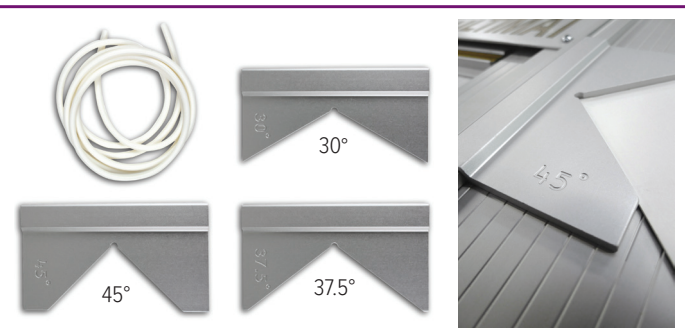

Features three different angle plates which clip instantly and precisely into the margin guide

- Use with both Ultimat Gold and Ultimat Futura (Ultimat Gold pictured)
- Provide predictable and accurate positioning for a mat board to be marked or cut on an angle
- The chosen angles provide lots of creative scope with no fiddly adjustments
- For special creative cutting more than one angle plate can be located in the matguide at one time
- Keencut product code: UGMAG.

2485	Multi-angle Cutting Gauge set	pack of 3 plates	£66.65
------	-------------------------------	------------------	--------

Reverse Bevel Stop *Optional*

Reverse Bevel Stop can be fitted to the Ultimat Futura or Gold

- This helps user to produce a reversed bevel mat without over or under cuts. Such mats can then accept 'slips' or 'fillets' producing a clean tight edge between the slip and the mat
- Keencut product code: UGREV.



4833	Reverse Bevel Stop	set	£27.00
------	--------------------	-----	--------

Margin Guide Extension Kit 750mm *Optional*

For controlling a cut up to 750mm (30") away from the margin guide. Kit includes a pair of 600mm support arms

- The unique and very useful 750mm (30") margin guide extension effectively extends the Futura base width up to 1000mm (39") wide
- Perfect for square and accurate positioning when cutting large matboards, multiple openings, title boxes or just very wide margins
- The matboard will stay square and flat when cutting up to 750mm (30") away from the edge of the matboard
- Keencut product code: UGMG.

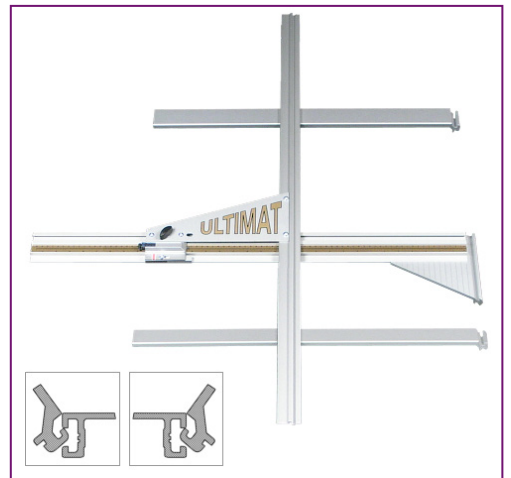

2484	Mat Guide Extension kit		£90.30
------	-------------------------	--	--------

KEENCUT Ultimat Upgrade Kits

Users of all Ultimat and Ultimat Gold cutters can upgrade to the latest Futura spec.

9269	Ultimat upgrade kit	1000	£323.00	7692	Ultimat Gold upgrade kit	1000	£323.00
9270	" " "	1200	n/a	7693	" " " "	1200	£340.00
9271	" " "	1500	n/a	7694	" " " "	1500	£374.00

These kits contain a new running rail and a new head. To fit, simply remove the old and bolt in the new. *Limited availability.*

Keencut Construction & Guarantees

- Pre-lubricated ball bearings on steel slide track for precision and low friction
- 100% manufactured by Keencut technicians in England
- Aluminium alloy construction
- Super grade anodising for lifetime good looks and function
- Designed specifically for the professional picture framer
- 5 year comprehensive guarantee
- 20 year replacement guarantee on all slide bearings



www.keencut.com



Authorised Distributor:

LION Picture Framing Supplies Ltd

Tel: 0121 773 1230 info@lionpic.co.uk

All prices quoted are correct as at January 2018. Please check on our website before ordering.



lionpic.co.uk