



Chop Service Ordering Guide

Learn how to calculate what size to order for:

- Standard Frames p3
- Stacked Frames p4
- Spacers p5
- Frame or Mount Slips p6
- St Ives p7
- L Styles p9
- Two-Way Ls p10
- Stretcher Bars in Lengths p11
- Floater Frames p12
- Panel Tray Frames p13
- Standard Aluminium Frames p14
- M430 Panel Tray Aluminium Frames p15
- Sub Frames p16



Chop Service Terminology

There are two key terms to understand when it comes to ordering moulding on our Chop Service:

Glass Size

This is the inner measurement you give us when ordering. It's the dimensions of the piece of acrylic/glass that will eventually drop into the frame. This will be smaller than the outside dimensions of the finished frame.

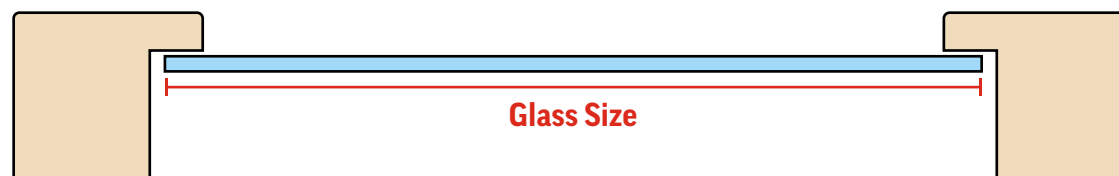

Fitting Tolerance

To allow a little wriggle room for the glass, mount and backing board, we automatically add 2mm Fitting Tolerance to the Glass Size you give us. This allows 1mm all round between glazing and frame.

If for some reason you don't want us to add fitting tolerance, just check the box for 'Do not add 2mm fitting tolerance'.

We can't vary the amount of tolerance we add - if you want more or less than 2mm select 'Do not add fitting tolerance' and then add your preferred tolerance to the glass size.

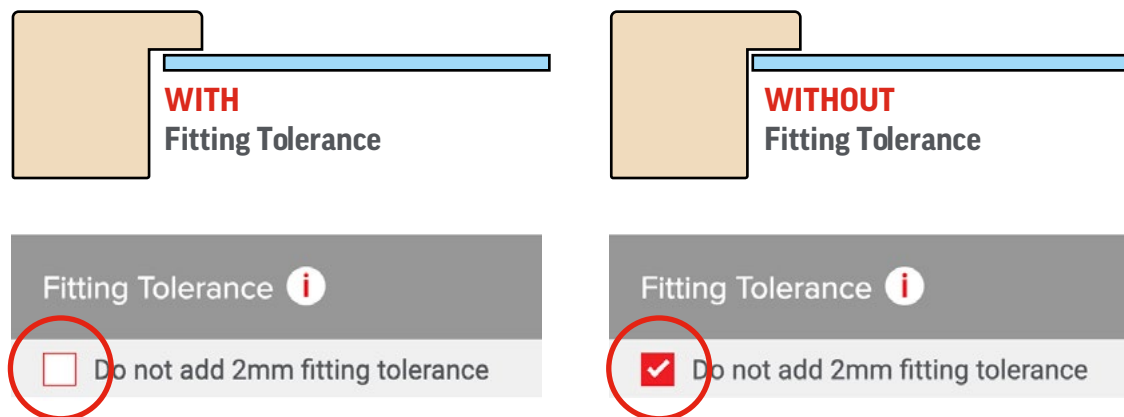

Standard Frames

- We cut to the **inside edge of the rebate**.
- Calculate the Glass Size of the finished frame by working out the size of the artwork plus any window mount.

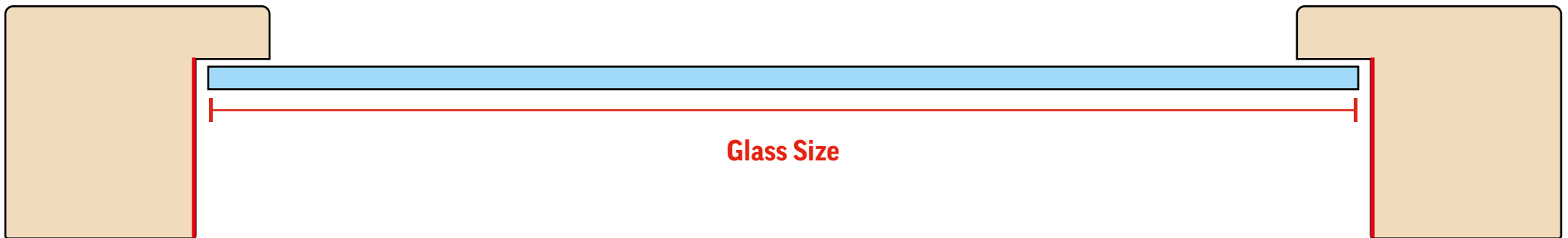

- Our Sales & Customer Service Team won't be able to calculate frame sizes for you.
- We can't cut a frame to a different edge of the profile to the one shown in **RED** on these diagrams.
- See page 2 for an explanation of Fitting Tolerance.

Stacked Frames

- If you want to stack two mouldings to make one frame.
 1. Inner Frame: Order the Glass Size.
 2. Outer Frame: Order Glass Size + 2 x (Width - Rebate).
- We recommend you choose to add Fitting Tolerance to both inner and outer frame.
- For the rebate size check your chevron. If you don't have a chevron you can work on the basis the rebate is 6 - 7mm*.
- We cannot cut frames to the outside size.

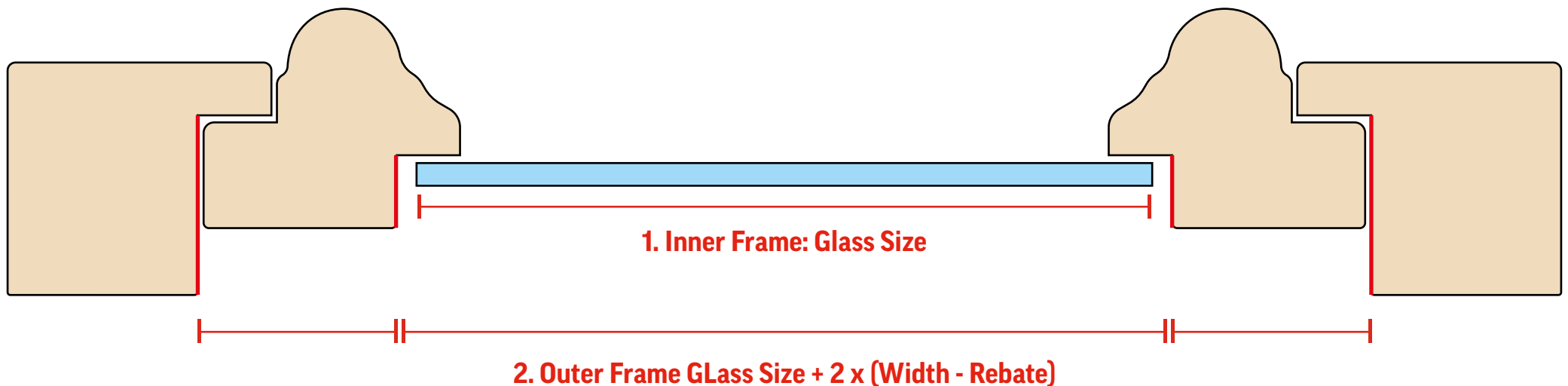
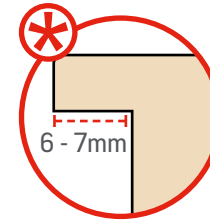

- Our Sales & Customer Service Team won't be able to calculate frame sizes for you.
- We can't cut a frame to a different edge of the profile to the one shown in **RED** on these diagrams.
- See page 2 for an explanation of Fitting Tolerance.

Spacers

- We cut to the **back edge** of the profile.
- We recommend you choose to add Fitting Tolerance to both spacer and outer frame.

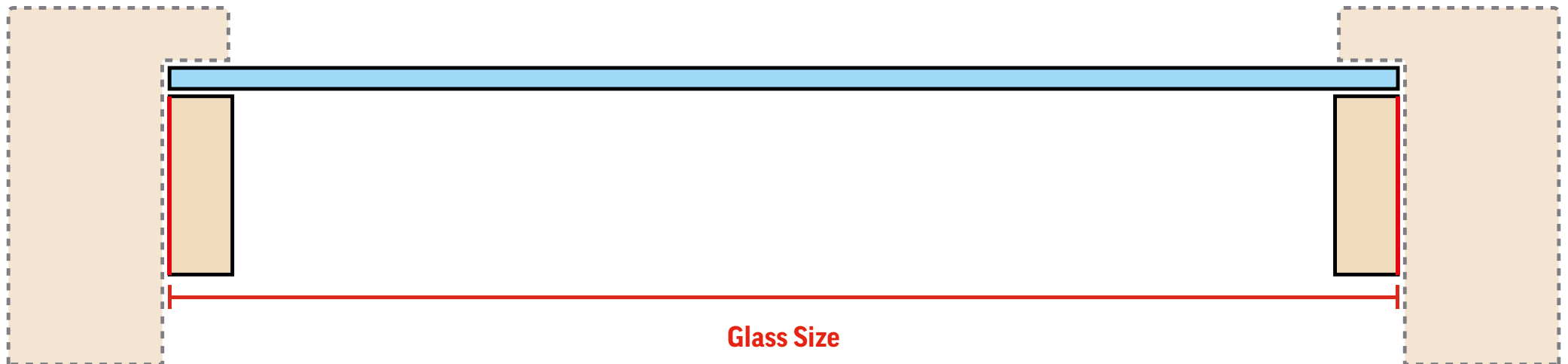

- Our Sales & Customer Service Team won't be able to calculate frame sizes for you.
- We can't cut a frame to a different edge of the profile to the one shown in **RED** on these diagrams.
- See page 2 for an explanation of Fitting Tolerance.

Frame or Mount Slips

- We cut to the **back edge** of the profile.
- We recommend that you select 'Do Not Add Fitting Tolerance' to slips as they should fit snugly into the outer frame.
- We recommend you choose to add Fitting Tolerance to both slip and outer frame.

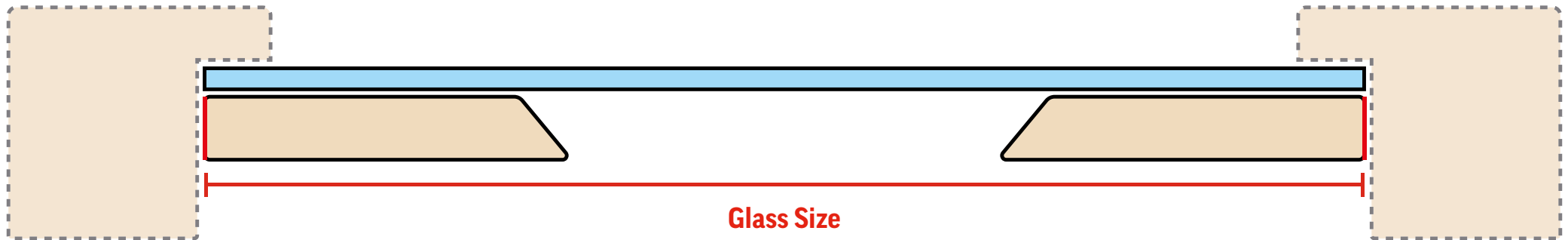

- Our Sales & Customer Service Team won't be able to calculate frame sizes for you.
- We can't cut a frame to a different edge of the profile to the one shown in **RED** on these diagrams.
- See page 2 for an explanation of Fitting Tolerance.

St Ives

- We cut to the **inside edge of the rebate**.

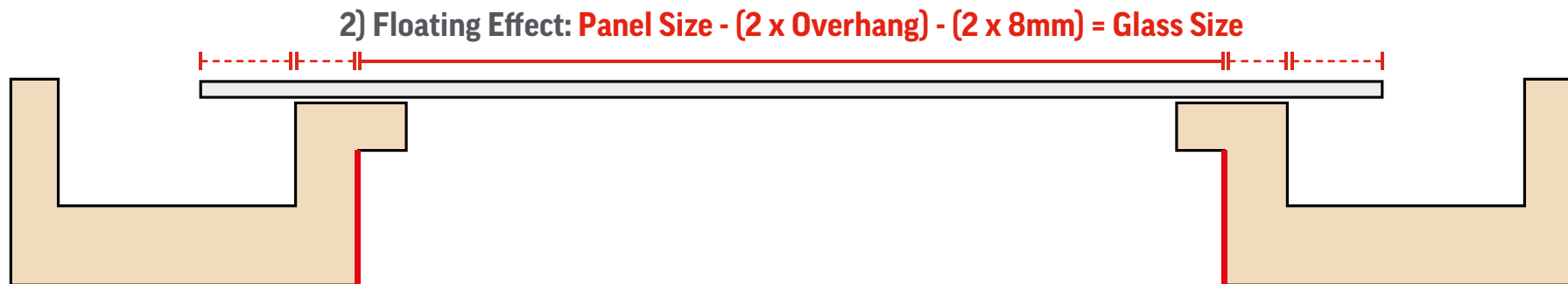
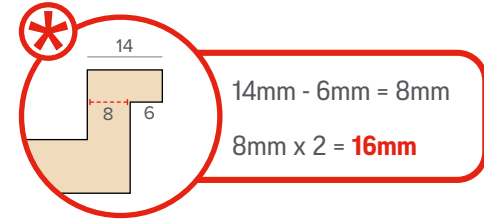

- Our Sales & Customer Service Team won't be able to calculate frame sizes for you.
- We can't cut a frame to a different edge of the profile to the one shown in **RED** on these diagrams.
- See page 2 for an explanation of Fitting Tolerance.

St Ives cont.

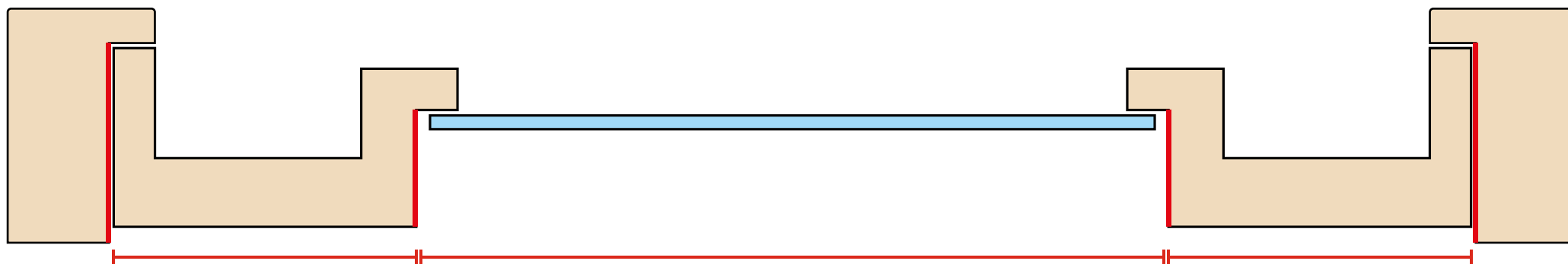
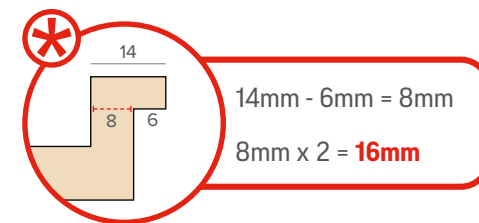

3) Stacked With Outer Frame: **St Ives Glass Size + ((St Ives Width - Rebate) x 2) = Outer Frame Glass Size**



- Our Sales & Customer Service Team won't be able to calculate frame sizes for you.
- We can't cut a frame to a different edge of the profile to the one shown in **RED** on these diagrams.
- See page 2 for an explanation of Fitting Tolerance.

L Styles

- These profiles are designed to make a Tray Frame for a stretched canvas. We cut to the **inside edge**.
- Calculate or measure the dimensions of the stretched canvas.
- Most framers add a 'Shadow Gap' between the canvas and the frame as it looks better than the frame being tight to the canvas.
- A 10mm shadow gap is most popular - so add 20mm to each dimension of your canvas.

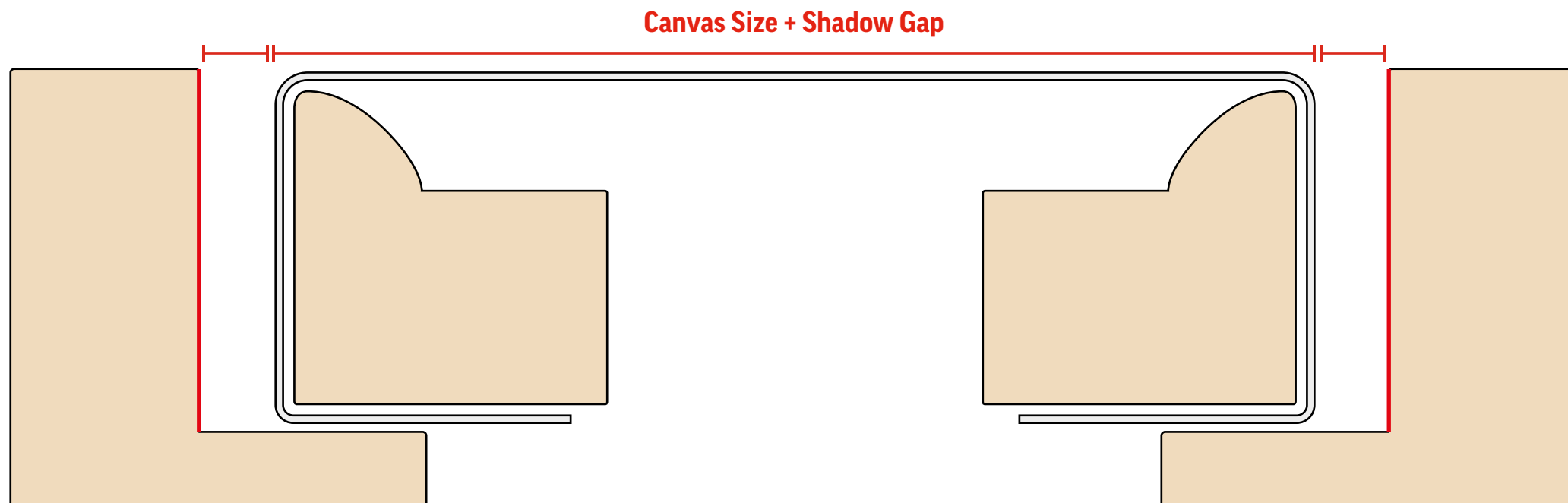

- Our Sales & Customer Service Team won't be able to calculate frame sizes for you.
- We can't cut a frame to a different edge of the profile to the one shown in **RED** on these diagrams.
- See page 2 for an explanation of Fitting Tolerance.

Two Way Ls

- These stepped profiles can be used to make tray frames for different depths of canvas. The stepped shape automatically creates a shadow gap.
- When ordering online you can choose whether to have the frame cut with either the tall or the short side surrounding the frame.

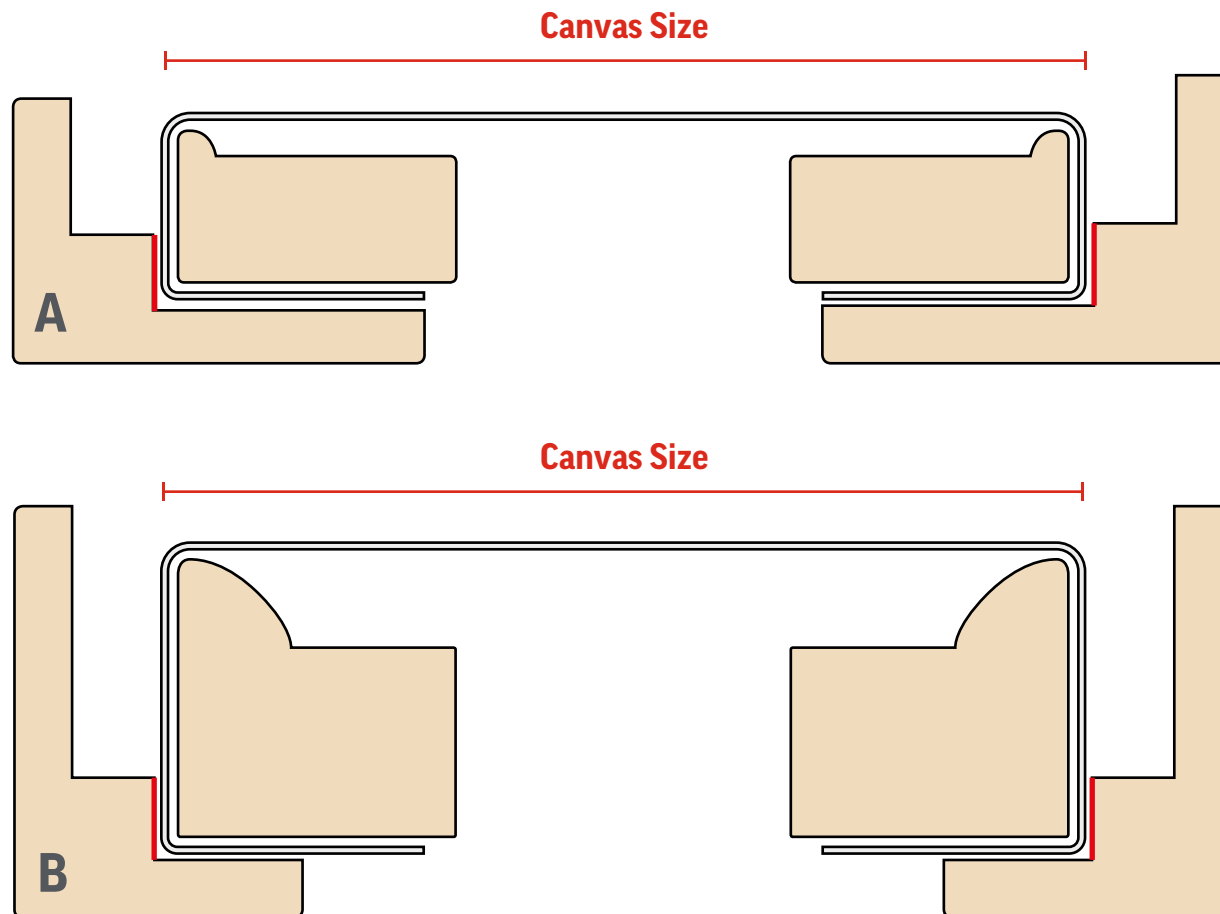
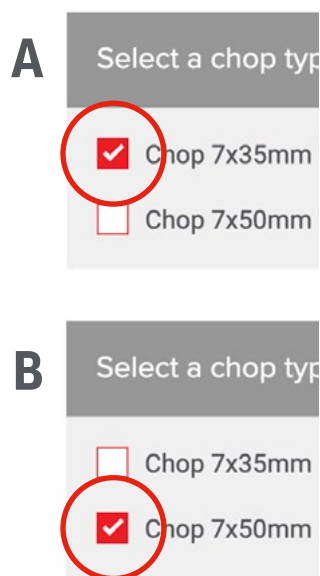

- Our Sales & Customer Service Team won't be able to calculate frame sizes for you.
- We can't cut a frame to a different edge of the profile to the one shown in **RED** on these diagrams.
- See page 2 for an explanation of Fitting Tolerance.

Stretcher Bars in Lengths

- We cut to the **back edge** of the profile.
- Order the finished size of the canvas you are stretching.

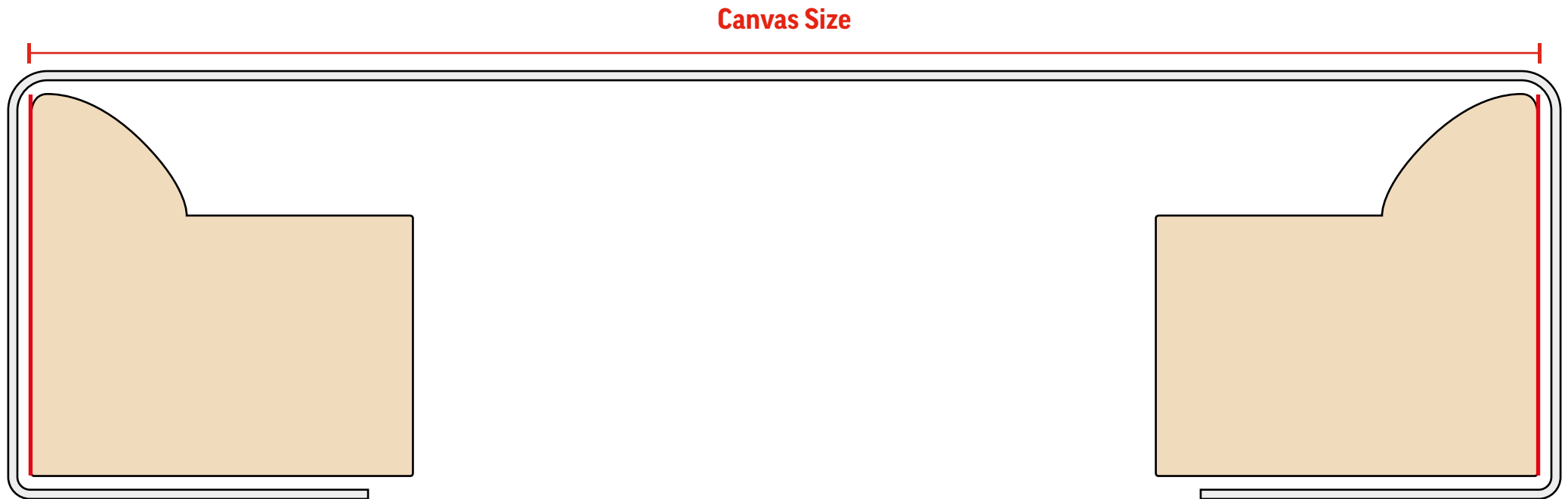

- Our Sales & Customer Service Team won't be able to calculate frame sizes for you.
- We can't cut a frame to a different edge of the profile to the one shown in **RED** on these diagrams.
- See page 2 for an explanation of Fitting Tolerance.

Floater Frames

- We cut to the **inside edge of the profile**.
- Measure the panel.
- Panels should fit snugly into this profile but we recommend adding Fitting Tolerance to give you a bit of wiggle room.

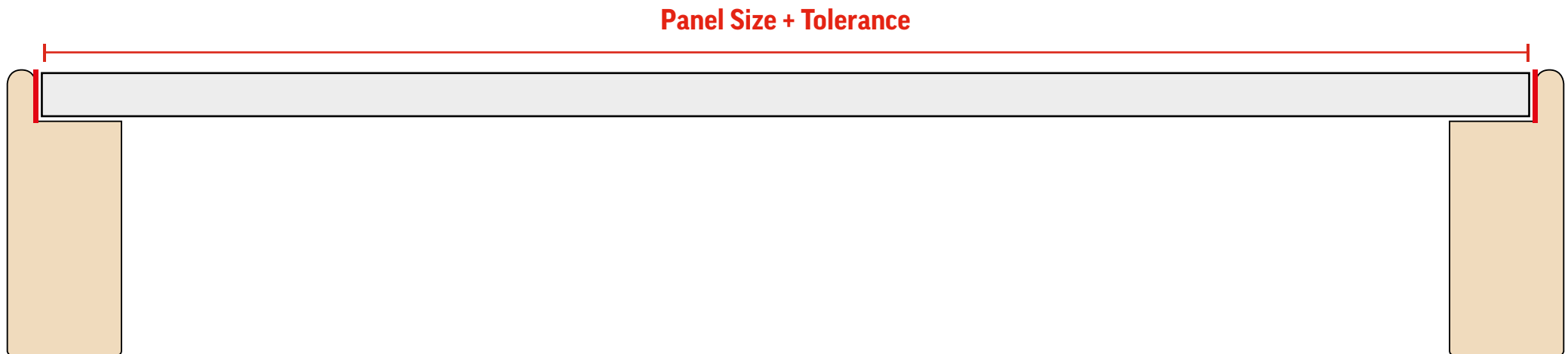

- Our Sales & Customer Service Team won't be able to calculate frame sizes for you.
- We can't cut a frame to a different edge of the profile to the one shown in **RED** on these diagrams.
- See page 2 for an explanation of Fitting Tolerance.

Panel Tray Frames

- We cut to the **inside edge of the profile**.
- Measure the panel then add 2 x shadow gap - up to 7mm for L2544 and L2545, up to 10mm for L2989 and L2990.
- Do not add tolerance to ensure that your shadow gap is accurate.

Fitting Tolerance **i**

Do not add 2mm fitting tolerance

Panel Size + (Shadow Gap x 2)

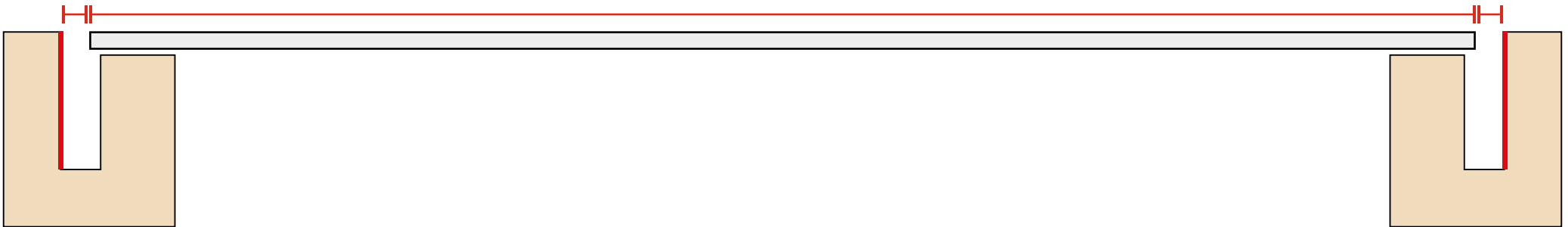

- Our Sales & Customer Service Team won't be able to calculate frame sizes for you.
- We can't cut a frame to a different edge of the profile to the one shown in **RED** on these diagrams.
- See page 2 for an explanation of Fitting Tolerance.

Standard Aluminium Frames

- We cut to the **inside edge of the profile**.
- Calculate the Glass Size of the finished frame by working out the size of the artwork plus any window mount.

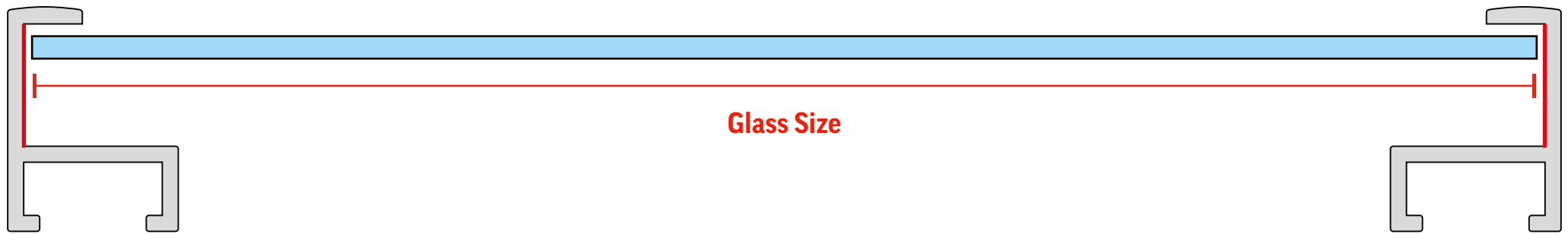

Aluminium Frame Hardware

- Make sure you've ordered your aluminium frame hardware, either as a single frame kit from the Chop Service page or separately in bulk.
- If any side of the frame is over 1000mm we recommend choosing **9772** Aluminium Frame Hardware Large.

This moulding has hardware kits available. Please select from the following:

- No Hardware Kit
- (198) Aluminium Frame Hardware Standard with Keyhole Hangers for Cord 1 pack Add £2.71
- (9772) Aluminium Frame Hardware Large with CWH3 Sawtooth Hangers 1 pack Add £5.70
- (197) Aluminium Frame Hardware Standard with CWH3 Sawtooth Hangers 1 pack Add £2.54



- Our Sales & Customer Service Team won't be able to calculate frame sizes for you.
- We can't cut a frame to a different edge of the profile to the one shown in **RED** on these diagrams.
- See page 2 for an explanation of Fitting Tolerance.

M430 Panel Tray Aluminium Frames

- We cut to the **inside edge of the profile**.
- Add a shadow gap of up to 15mm to the size of the panel you're framing.

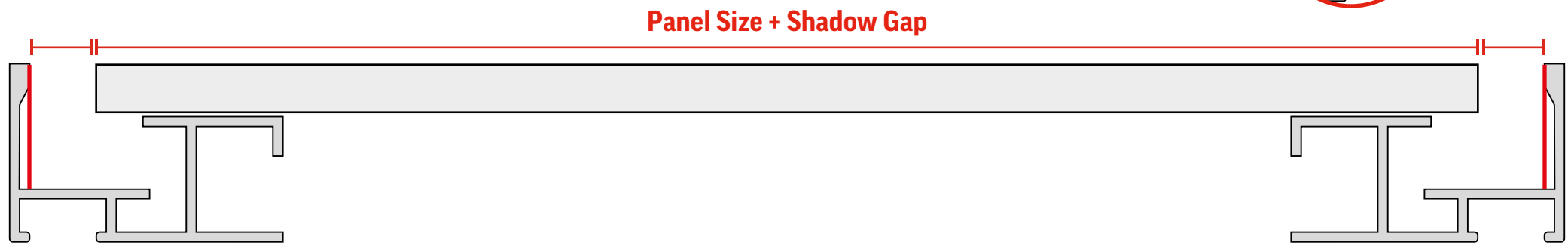
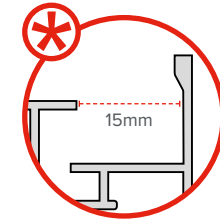

Aluminium Frame Hardware

- Make sure you've ordered your aluminium frame hardware, either as a single frame kit from the Chop Service page or separately in bulk.
- If any side of the frame is over 1000mm we recommend choosing **9772** Aluminium Frame Hardware Large.

This moulding has hardware kits available. Please select from the following:

- No Hardware Kit
- (198) Aluminium Frame Hardware Standard with Keyhole Hangers for Cord 1 pack Add £2.71
- (9772) Aluminium Frame Hardware Large with CWH3 Sawtooth Hangers 1 pack Add £5.70
- (197) Aluminium Frame Hardware Standard with CWH3 Sawtooth Hangers 1 pack Add £2.54



- Our Sales & Customer Service Team won't be able to calculate frame sizes for you.
- We can't cut a frame to a different edge of the profile to the one shown in **RED** on these diagrams.
- See page 2 for an explanation of Fitting Tolerance.

Sub Frames

- We cut to the **back edge of the profile**.
- Subtract 2 x your desired overhang from the size of the panel you're mounting. The overhang is usually around 25mm all round.

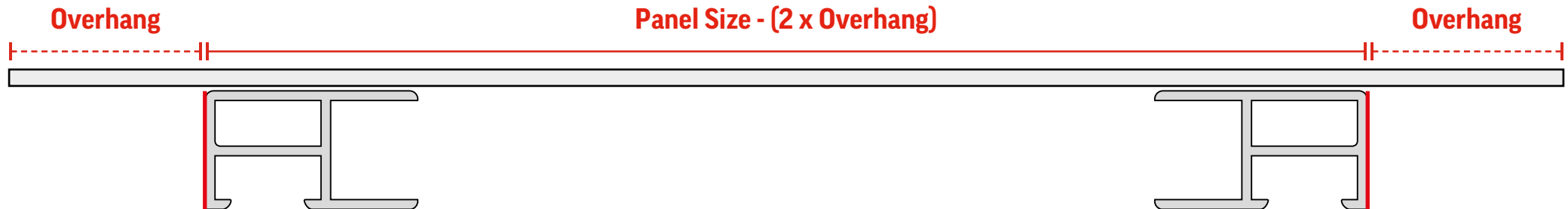

Sub Frame Hardware

- Sub Frame is square cut, and joined with moulding plastic push in corners. Select a hardware kit from the Chop Service page.

This moulding has hardware kits available. Please select from the following:

- No Hardware Kit
- (9295) SUB15 Moulded Push In Corners 1 Frame Join & Hang Kit Add £4.20
- (9295A) SUB15 Moulded Push In Corners 40 pack for 10 frames Add £25.95
- (9295B) SUB15 Moulded Push In Corner 500 pack for 125 Frames Add £292.00



- Our Sales & Customer Service Team won't be able to calculate frame sizes for you.
- We can't cut a frame to a different edge of the profile to the one shown in **RED** on these diagrams.
- See page 2 for an explanation of Fitting Tolerance.

'How To' Videos

- Scan the QR codes to watch our useful 'How To' videos
- Find more on our YouTube channel - youtube.com/LIONPFSLtd

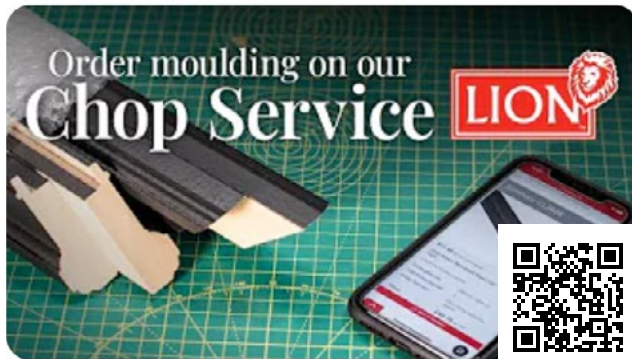

The LION Chop Service



3 Ways to use St Ives Picture Frame Moulding



How to Frame a Canvas

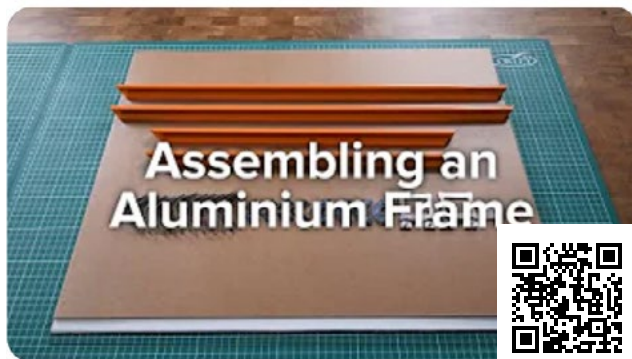

How To Assemble an Aluminium Frame



How to Fit a SUB15 Pre Taped Aluminium Sub Frame

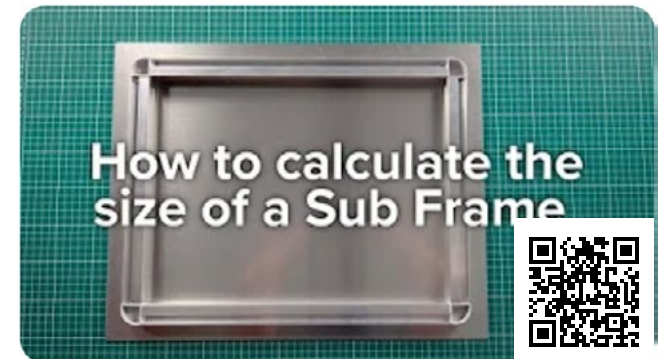

How to Calculate the Size of a Sub Frame